



# THE ELEMENT SIX CVD DIAMOND HANDBOOK

**elementsix™**  
a De Beers Group Company

---

Contact Element Six Technologies at [technologies@e6.com](mailto:technologies@e6.com)

# CONTENTS

INTRODUCING DIAMOND	3
PHYSICAL PROPERTIES	4
DIAMOND CLASSIFICATION	5
DIAMOND SYNTHESIS	6
TYPES OF CVD DIAMOND	7
CRYSTALLOGRAPHY	8
MECHANICAL STRENGTH	9
POLISHING OF DIAMOND	10
DIAMOND SURFACES	11
<b>PROPERTIES</b>	
OPTICAL PROPERTIES	12
OPTICAL CONSTANTS	13
RAMAN SCATTERING	14
SINGLE CRYSTAL OPTICS	15
POLYCRYSTALLINE OPTICS	16
EMISSIVITY AND RF WINDOWS	17
PRECISION COMPONENTS	18
THERMAL PROPERTIES	19
ELECTRONIC PROPERTIES	20
ELECTROCHEMICAL PROPERTIES	21
<b>DATASHEETS</b>	
ELECTRONIC GRADES	22
OPTICAL AND RF GRADES	23
MECHANICAL GRADES	24
THERMAL GRADES	25
ELECTROCHEMICAL GRADE	26
<b>FURTHER READING</b>	27

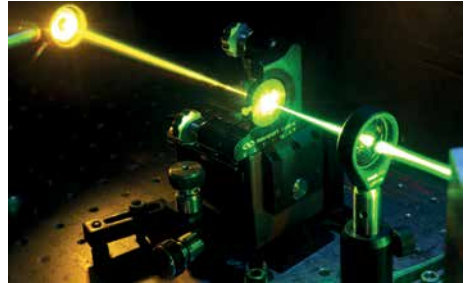

Advances in the synthesis and processing technology for CVD diamond has resulted in materials with exceptional diamond properties in practical components. Engineered single crystal CVD diamond, with ultra low absorption and birefringence combined with long optical path lengths, has made [Monolithic Diamond Raman Lasers](#) a practical reality.

# INTRODUCING DIAMOND

Diamond is characterised by its exceptional hardness, robustness and its optical and thermal properties; pre-eminent as a gemstone and an industrial tool.

Natural diamond has an inherent variability and scarcity that limits its use in engineering applications. Developments in synthesis processes have enabled the production of consistently engineered synthetic diamond; firstly in the 1950s using high pressure and high temperature and later using chemical vapour deposition in the 1980s to produce the exceptional covalent crystal diamond.

The modern industrial world consumes approximately 800 tonnes of synthetic diamond, around 150 times the amount of natural diamond mined as gemstones.

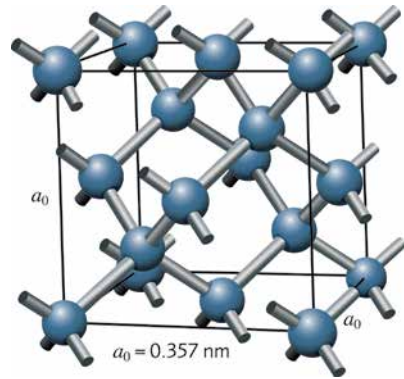

## IT IS ALL IN THE STRUCTURE

Diamond's properties derive from its structure; tetrahedral covalent bonds between its four nearest neighbours, linked in a cubic lattice. This strongly bonded, tightly packed, dense and rigid structure gives rise to its outstanding properties. Manipulating the impact of defects and the synthesis conditions means that material scientists have been able to optimise and tailor the remarkable properties of diamond for a wide range of applications.



*High pressure high temperature synthetic diamond is usually nitrogen doped, giving it a distinctive yellow hue.*

boron 5 B 10.811	carbon 6 C 12.011	nitrogen 7 N 14.007
aluminium 13 AL 26.981	silicon 14 Si 28.085	phosphorus 15 P 30.973

*Carbon's position as a group IV element above silicon in the periodic table.*

# PHYSICAL PROPERTIES

PROPERTY	VALUE
DENSITY	$3.51524 \times 10^3 \text{ kgm}^{-3}$
NUMBER DENSITY	$1.77 \times 10^{23} \text{ per cm}^3$
LATTICE TYPE	Cubic Fd3m- $0_h^7$
LATTICE SPACING	Lattice constant between 0.356683 +/-0.000001 and 0.356725 +/-0.000003 nm at 298 K
FRACTURE TOUGHNESS $K_{Ic}$	5 MPa m <sup>0.5</sup> Single Crystal 8.5 MPa m <sup>0.5</sup> Polycrystalline
POISSON'S RATIO	0.1
YOUNG'S MODULUS	1050 GPa
FRACTURE STRENGTH	2.5 to 3 GPa Single Crystal surface finish dependent 200 to 1100 MPa Polycrystalline grain size and grade dependent
FATIGUE LIFE	>95% strength after >>10 <sup>7</sup> cycles to 70% of FS
FRACTURE PLANE	{111} and occasionally {110}
WEIBULL MODULUS	2.55 Single Crystal 10 Growth Surface Polycrystalline 20 Nucleation surface Polycrystalline
HARDNESS	70 to 120 GPa Single crystal (Plane and direction of indent dependent) ~81 ±18 GPa Polycrystalline (Grain orientation dependent)
FRICTION COEFFICIENT ( $\mu$ )	0.05 to 0.15 (orientation dependent) In air (requires surface termination)

# DIAMOND CLASSIFICATION

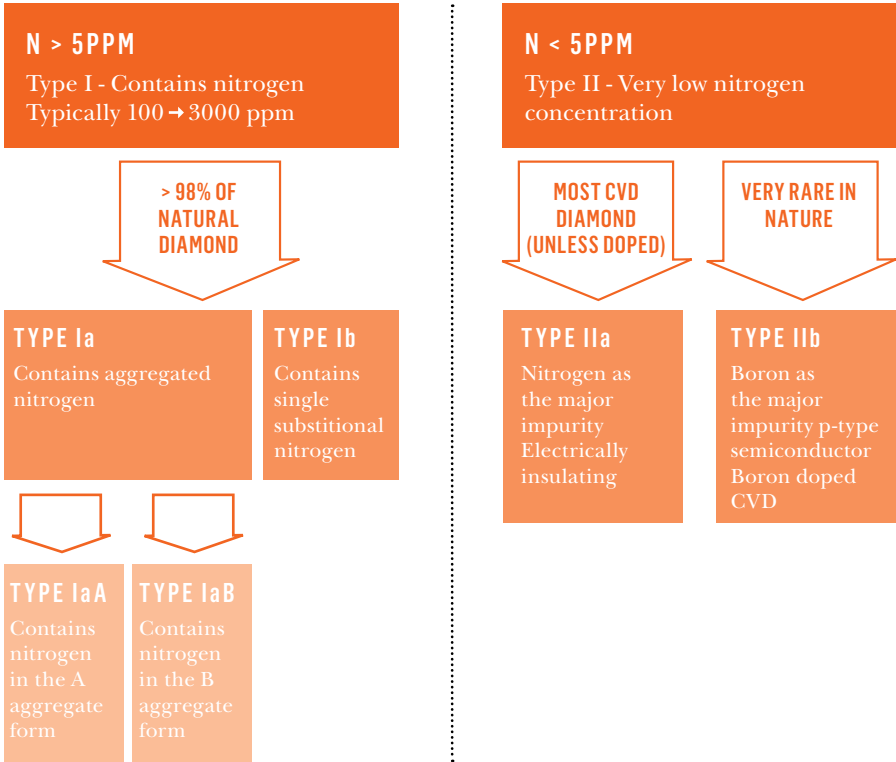

Natural diamonds were first classified according to their optical properties. The majority, being Type I, have an absorption edge of around 330 nm and a small group, being Type II, have an absorption edge of about 220 nm. Over the years this natural classification scheme has been extended and further linked to different predominant defects, such as nitrogen and nitrogen clusters. In its broadest sense, this

classification scheme remains relevant to synthetic diamond, in that most HPHT grown diamond falls into the type Ib classification and most CVD into type IIa, due to their different nitrogen levels. However, within this there are now multiple polycrystalline and single crystal grades, developed with specific tailored properties that this simple classification system does not distinguish between.

# DIAMOND SYNTHESIS

## HPHT

The vast majority of synthetic diamond is made by high pressure and high temperature diamond (HPHT) methods. HPHT aims to mimic the thermodynamic conditions in nature that diamond forms in, but with the addition of a molten metal solvent / catalyst to reduce the large kinetic barrier and act as transport media for dissolved carbon. Material grown this way typically has a yellow hue, as a consequence of nitrogen incorporation into the diamond lattice from the atmosphere and growth materials.

## CHEMICAL VAPOUR DEPOSITION (CVD)

CVD diamond exploits the relatively small difference in stability between the two allotropes ( $sp^2$  &  $sp^3$ ) of carbon. Create the right surface conditions, the presence of atomic hydrogen and surface temperatures above  $\sim 600^\circ\text{C}$  and the formation of diamond depends on having a faster nucleation and growth rate than graphite.

The growth conditions are created by thermal disassociation of hydrogen, and a gaseous source of carbon in plasma, with a gas temperature above  $2000^\circ\text{C}$ .

The plasma can be heated by microwaves, radio frequency, lasers, direct current, hot filament and chemical reactions. The nucleation and growth of continuous diamond requires a substrate with refractory characteristics, stable carbide formation and a low thermal expansion coefficient.

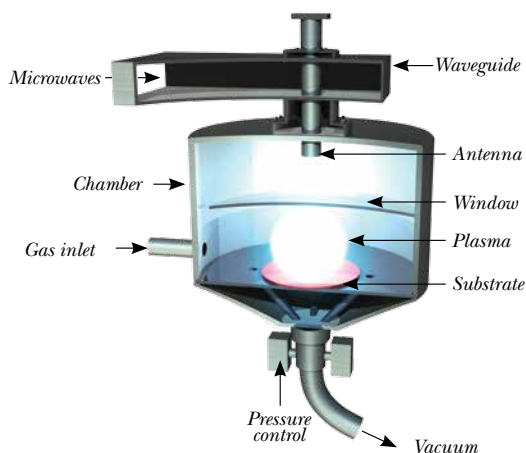

After nearly 4 decades of stop-start research into CVD diamond growth, microwave plasma enhanced CVD diamond synthesis emerged as a commercial synthesis method in the 1990s. The growth rates and control over purity of this method lends itself to manufacturing high quality, free-standing, polycrystalline and single crystal CVD diamond.

# TYPES OF CVD DIAMOND

## TECHNICAL CERAMIC

CVD diamond is sometimes classified by its grain size: ultra nano crystalline (< 10 nm), nano crystalline (< 50 nm) micro crystalline (< 500 μm) and single crystal diamond. The grain size depends on the synthesis conditions, substrate and layer thickness. Layers above ~ 50 μm can be removed from the carrier substrates, leaving free standing bulk CVD diamond materials.

## POLYCRYSTALLINE CVD DIAMOND

By controlling the impurities and the grain boundaries, free standing polycrystalline diamond wafers can be fabricated 120 mm in diameter, with thermal and infrared optical properties that approach highest quality perfect diamond. Free-standing polycrystalline diamond wafers 140 mm in diameter that are more durable, with finer grains, with thermal conductivities still more than 2.5 times that of copper are also manufactured.

## SINGLE CRYSTAL CVD DIAMOND

Single crystal diamond materials, with uniformly exceptional Type IIa optical, thermal and mechanical properties, are routinely available up to 8 × 8 × 2 mm.

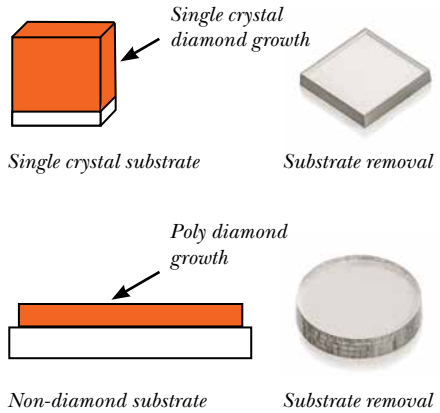

### SINGLE CRYSTAL CVD DIAMOND GRADES

<b>SINGLE CRYSTAL</b>	Engineered replacement for natural type IIa diamond
<b>OPTICAL GRADE</b>	Low absorption and birefringence diamond
<b>DETECTOR GRADE</b>	Ultrahigh purity for quantum optics and electronics

### POLYCRYSTALLINE CVD DIAMOND

<b>OPTICAL GRADE</b>	Engineered for far infrared laser optical applications
<b>ELECTRONIC GRADE</b>	Ultrahigh purity material for large area passive electronics
<b>THERMAL GRADES</b>	High thermal conductivity diamond heat spreading
<b>MECHANICAL GRADES</b>	High strength diamond for precision machining
<b>ELECTRO-CHEMISTRY GRADES</b>	Boron doped diamond for electrochemical applications

# CRYSTALLOGRAPHY

## DIAMOND STRUCTURE

Each carbon atom in diamond is bonded to its four nearest neighbours in a regular tetrahedron. These are arranged in a variation of the face centred cubic structure  $Fd\bar{3}m-0_h^7$

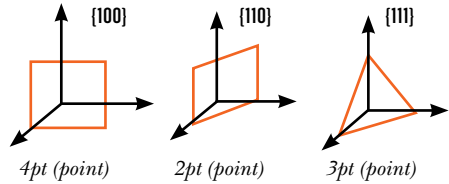

The three primary planes to consider for the octahedral diamond crystal are the (111), (100) and (110) planes. The nomenclature, more commonly used within the diamond industry, describe these as 3 point, 4 point and 2 point respectively.

The majority of CVD single crystal diamond is available with (100) orientated surfaces, with (110) edges, while the (111) is the cleavage plane. All of these surfaces can be presented in CVD diamond engineered products.

FACE PLANE	4PT (100)	2PT (110)	3PT (111)
4PT (100)	0° 90°	45° 90°	54° 44'
2PT (110)	45° 90°	0° 60° 90°	35° 16' 90°
3PT (111)	54° 44'	35° 16' 90°	0° 72° 32'

## POLYCRYSTALLINE DIAMOND

The grain structure of polycrystalline CVD diamond has a non-uniform composition, due to the growth process. Small randomly orientated grains form during the nucleation process, then grains with facets favoured by the growth conditions rapidly form large grains, that are ~ 10% of the film thickness in diameter, elongated in the direction of growth. When processed it still presents an inhomogeneous surface of many orientations.

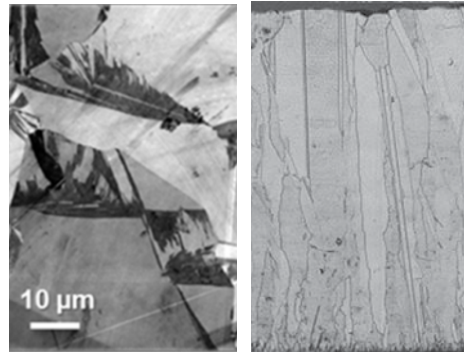

*SEM image of the polished surface of boron doped diamond, highlighting the different orientations. A polished cross section, illustrating the elongated structure originating from the nucleation surface along the direction of growth.*



# MECHANICAL STRENGTH

## STRENGTH OF DIAMOND

The covalent carbon to carbon bonds make diamond a very high strength material. The extreme rigidity of the diamond lattice also makes it a very stiff material, thus diamond is the ultimate high strength ceramic. The stress to fracture diamond is related to the size of the critical flaws in the material.

## STRENGTH OF SINGLE CRYSTAL

Tensile fracture testing of single crystal diamond finds the critical flaw size to be  $\sim 100$  nm. In mechanical testing the fracture strength is dependent on the surface finish and volume under test. With careful surface preparation,  $3 \times 5 \times 0.2$  mm samples achieve fracture stresses in the region of 2.5 - 3.0 GPa.

## STRENGTH OF POLYCRYSTALLINE DIAMOND

Bulk polycrystalline diamond is in the range 200 to 1100 MPa. It is significantly weaker due to the critical flaw found to be proportional to the grain size. Since the critical flaw / grain size is large at  $\sim 50$  to  $300 \mu\text{m}$ , polycrystalline diamond strength is relatively independent of surface finish, with a Weibull modulus of  $\sim 20$  when grain size is above  $\sim 100 \mu\text{m}$ .

With grain size increasing with layer thickness, strength is also dependent on thickness. Grain size is also dependent on the growth conditions and the orientation of the layer; with the nucleation surface in tension, the fracture stress is higher and the differences between grades less pronounced. In use, consideration should be given to which side is under tension.

After  $10^7$  cycles to 70% of fracture stress, there has been found to be no degradation expected in fracture strength.

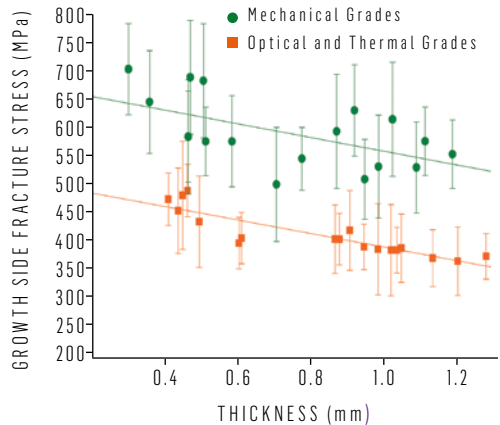

*The strength of polycrystalline diamond is dependent on the grain size. Finer grained mechanical recipes are stronger, whilst material from all recipes exhibit a dependency with thickness. This effect is most pronounced on the growth surface.*

# POLISHING OF DIAMOND

Processing the hardest bulk material is not trivial. To date most methods still rely on diamond to process diamond. The {111} plane of diamond is harder (up to 45%) and more wear resistant than the others.

## LAPPING

Rough processing of diamond is achieved using lapidary processes with a diamond grit slurry to remove material quickly. The physical wear mechanism is brittle fracture, leaving a rough surface with significant sub-surface damage.

## SCAIFE POLISHING

For single crystal diamond, by confining the direction of the wear fracture plane, low damage and low surface roughness can be achieved. The diamond is pressed onto a high speed rotating cast iron plate, a scaife, which has diamond particles embedded. It can achieve high surface finish  $R_a < 1$  nm with low damage.

## RESIN BONDED WHEEL POLISHING

This can be used to process both single crystal and polycrystalline diamond. Large areas and higher flatness can be achieved, however the subsurface processing damage is more severe than with scaife polishing.

## ETCHING OF DIAMOND

CVD diamond can be etched in high pH chemical mechanical polishing (CMP) slurries and in reactive ion etching plasma based process.

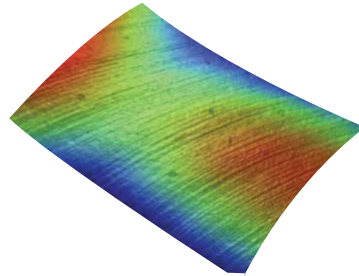

*High quality, low damage surfaces prepared on single crystal diamond by traditional scaife polishing. The shallow polishing grooves,  $< 5$  nm are  $> 20$  nm wide.*

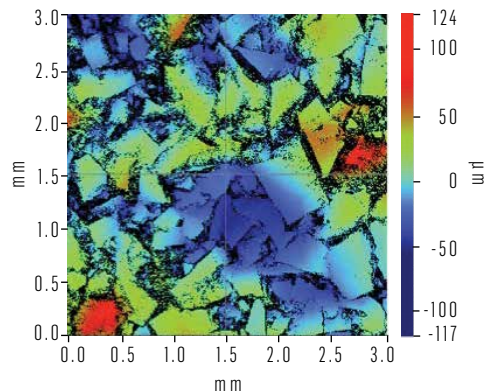

*Polycrystalline diamond, polished with a fixed grit diamond wheel. The grain relief is due to the different grain orientations, which polish at different rates.*

# DIAMOND SURFACES

## SURFACE TERMINATION

The diamond lattice terminates with dangling carbon bonds and typically O and OH groups covalently bond to them. The surface can also be terminated with hydrogen via a plasma treatment process. Exposed diamond surfaces have an inherent affinity for oils and dust particulates.

## CLEANING DIAMOND

Residual surface contamination can be removed from diamond using aggressive high temperature, > 150°C oxidising solutions, such as a combination of acid, e.g. H<sub>2</sub>SO<sub>4</sub> and an oxidising agent, e.g. KNO<sub>3</sub>. These types of cleaning steps are used in the manufacturing processes of bulk CVD diamond and leave the diamond surface with an oxygen termination. Cleaning diamond, and/or care to avoid surface contamination, are required immediately prior to processes such as bonding and metallisation.

## OXIDATION AND GRAPHITISATION

The thermal oxidation in the air starts at above 600°C. In a reducing atmosphere, e.g. H<sub>2</sub>, the onset of graphitisation is above 1300°C. Surface graphitisation can also occur under ion bombardment, such as with low pressure plasma cleaning processes.

## CARBIDE FORMATION

Two distinct groups of metals react with diamond. The first group form their stable carbides, such as Si, W & Ti. The second group, including Fe, Co, Cr & Ni are solvents for carbon and exhibit poor/no adhesion via graphitised interfaces.

## METALISATION & OPTICAL COATINGS

Ohmic metal carbide contacts can be formed using thin film, multi-layer metal coatings, with a carbide former as the basis for adhesion, followed by a stable inert metal such as Au, Pt. Stable to ~ 400°C, these coatings are used for the indirect attachment of contacts or heat sinks. Dielectric optical coatings can also be employed using extremely thin carbide adhesion layers.



*Mounted ATR prisms for spectroscopy.*

## BRAZING

CVD diamond can be attached using *active* brazes, formulated to form a stable carbide interface, in high temperature vacuum processes, at ~ 800°C. Interface shear strengths > 200 MPa can be achieved. The stresses generated by the thermal expansion mismatch between diamond and most mount materials requires careful consideration.

# OPTICAL PROPERTIES

## TRANSMISSION SPECTRUM

The exceptional properties of synthetic CVD diamond place it at the pinnacle of modern optical materials, from ultraviolet to radio frequency transmission. The intrinsic optical properties are governed by its band gap in the deep UV, with a

cut off at 225 nm (5.47 eV). It is then transparent in the ultra violet, visible near infrared regions, far infrared and radio frequencies, with only weak phonon band absorption, in the  $\sim 2.5$  to  $7 \mu\text{m}$  region peaking at  $14 \text{ cm}^{-1}$  at  $4.63 \mu\text{m}$ .

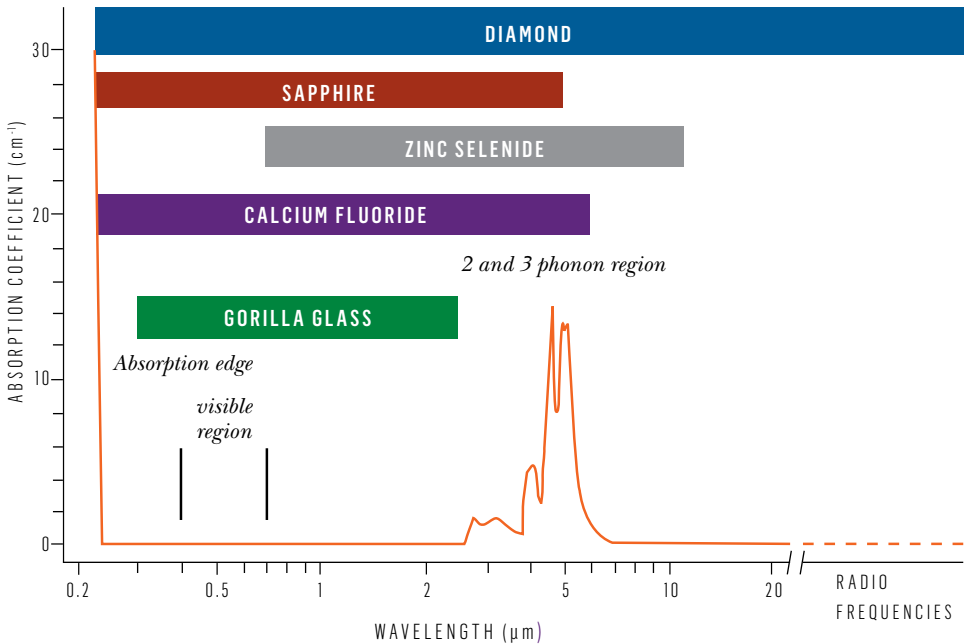

*Absorption coefficient for ultra high purity CVD diamond from the UV cut-off 225 nm to far infrared region. Diamond has a relatively low dielectric constant making it highly suitable as a window for radio frequency applications.*

# OPTICAL CONSTANTS

## REFRACTIVE INDEX

Diamond has a refractive index in the range of 2.7, at 226 nm, to 2.37 at 10.6 μm. The incident reflectivity is in the range 21.3 % to 16.7%. The Sellmeier equation approximates the dispersion curve for 226 to 650 nm, where λ is in nm.

$$n(\lambda) = \left[ 1 + \frac{0.3306\lambda^2}{\lambda^2 - (175)^2} + \frac{4.3356\lambda^2}{\lambda^2 - (106)^2} \right]^{0.5}$$

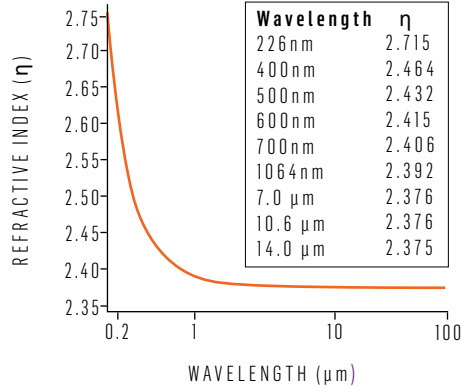

In the range 2.5 to 25 μm, dispersion is better approximated by the Hertzberger expression.

$$n(\lambda) = 2.37837 + \frac{1.18897}{\frac{\lambda}{1000} - 0.028} - \frac{1.0083 \times 10^{-4}}{\left(\frac{\lambda}{1000} - 0.028\right)^2} - 2.3676 \times 10^{-5} \lambda^2 + 3.24263 \times 10^{-8} \lambda^4$$

The thermo-optic coefficient of refractive index  $(1/n) \times (dn/dT)$  is in the range  $3.2$  to  $6.7 \times 10^{-6} \text{ K}^{-1}$  IR region,  $2$  to  $4.0 \times 10^{-6} \text{ K}^{-1}$  in the UV to NIR region.

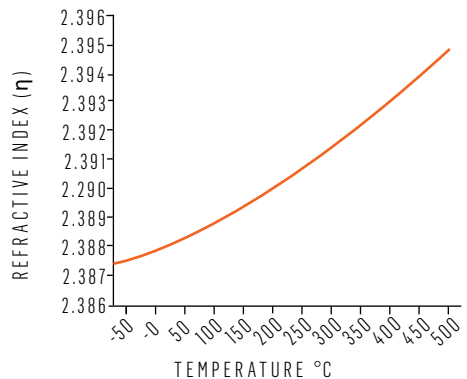

# RAMAN SCATTERING

## RAMAN SPECTROSCOPY

The Raman frequency of diamond, at RT, is  $\omega=1332.3 \text{ cm}^{-1}$ , line width  $1.5 \text{ cm}^{-1}$ . The peak shape, position and luminescence in the Raman spectroscopy can be used by material scientists to assess diamond film quality, including phase purity, crystalline perfection and stresses.

In applications, the Raman shift can be used as a sensor itself. Temperature dependency is given by the semi-empirical expression:

$$T = \frac{Dhc\omega_0}{k \ln \left\{ 1 + C / [\omega_0 - \omega(T)] \right\}}$$

where  $\omega_0 = 1333 \pm 0.6 \text{ cm}^{-1}$ ,  $C = 61.14 \pm 5$  and  $D = 0.787 \pm 0.03$ .  $C$  &  $D$  are fitted constants and  $\omega_0$  is the Raman frequency at  $T = 0 \text{ K}$ .

The approximate relationship of peak shift with hydrostatic pressure is given by:

$$\Delta\omega(P) = 3.2 \text{ cm}^{-1} \text{ GPa}^{-1}$$

## RAMAN LASER

CVD synthesis enables intra-cavity laser optics, including Raman frequency converters. In comparison with other high gain Raman crystals, synthetic diamond has a larger frequency shift at much higher brightness.

$$\text{Raman Figure of Merit} = \frac{kgL}{(d\eta/dT)\Delta\lambda}$$

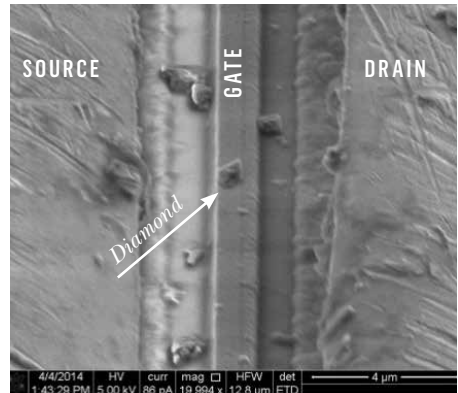

The Raman peak shift of nanometre scale diamond crystallites can be used as a *micro temperature probe* measuring the gate junction temperature of electronic devices such as transistor gate structures.

	SC CVD DIAMOND	KGW $\text{KGD}(\text{WO}_4)_2$	$\text{YVO}_4$	$\text{BA}(\text{NO}_3)_2$
RAMAN GAIN	15	4	5	11
RAMAN SHIFT $\Delta\lambda \text{ cm}^{-1}$	1332	901	892	1047
CRYSTAL LENGTH $L \text{ mm}$	8	25	25	25
THERMAL CONDUCTIVITY $\text{W m}^{-1}\text{K}^{-1}$	>2000	5	5.2	1.2
RAMAN FIGURE OF MERIT	1440	3	20	1

## UV TO NIR OPTICAL PROPERTIES

Large area, up to  $\sim 60 \text{ mm}^2$  high purity single crystal CVD diamond is available that enables many applications in the UV, visible and near infrared bands.

## SCATTER

Scatter from CVD single crystal diamond is very low, as the macroscopic defects and surface finish that gives rise to scatter are highly controlled. Total forward scatter can be as low as 0.02 % at 1064 nm.

## SINGLE CRYSTAL CVD DIAMOND

Absorption in the range 220 to  $\sim 2.5 \mu\text{m}$  is mainly attributable to nitrogen. When nitrogen is less than 5 ppm, CVD single crystal diamond has Type IIa optical properties. Broad spectral range and low absorption below  $\sim 1 \mu\text{m}$ .

## OPTICAL GRADE

When nitrogen is less than 20 ppb, single crystal diamond has the lowest possible absorption. Suitable for the most demanding optical applications, this is a new class of synthetic optical material.

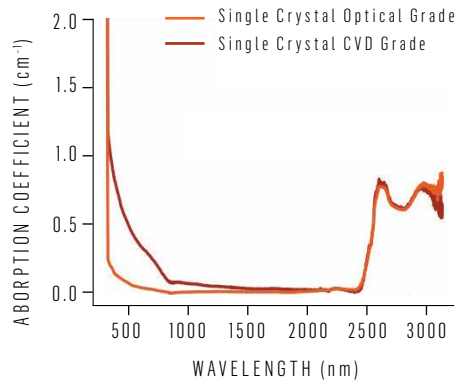

## STRAIN INDUCED BIREFRINGENCE

Due to its cubic lattice symmetry, diamond is an optically isotropic material; the refractive index should be independent of the polarisation of light. However the presence of strain, typically from grown-in defects, leads to birefringence. With careful engineering, the defect density and orientation of the diamond optical component results in samples with isotropic refractive properties with no significant loss of polarisation of light. The birefringence loss of polarisation ( $\Delta n$ ) can be  $< 2 \times 10^{-6}$  in the visible and NIR bands.

# POLYCRYSTALLINE OPTICS

## POLYCRYSTALLINE OPTICAL GRADE DIAMOND

With low absorption across the UV, VIS and IR band, polycrystalline diamond is also an excellent optical material. Combined with its thermal and mechanical properties it offers  $> 2 \times$  power handling capability compared to conventional IR laser optics.

Competitive grain growth and a high density of defects, such as stacking faults, result in relatively high strain. Consequently it is less suitable for low birefringence, or UV to NIR applications where scatter is more of consideration. Diamond has a refractive index of 2.38 at  $10.6 \mu\text{m}$  and thin film AR coatings can be used to achieve  $> 99\%$  transmittance.

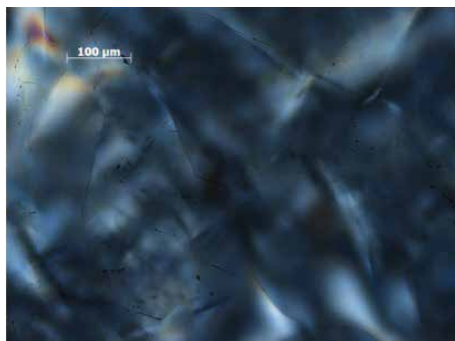

*The strain induced birefringence results in the colour in this cross polar transmitted light optical micrograph of polycrystalline transparent grade CVD diamond.*

## SCATTER

Scatter losses are insignificant below  $2 \mu\text{m}$ ; polycrystalline diamond has excellent infrared optical properties. High incident angle scatter is correlated with micro-features in the diamond, while low angle scatter is attributed to strain induced birefringence. The residual extinction coefficient of diamond is  $0.04$  to  $0.07 \text{ cm}^{-1}$  at  $10.6 \mu\text{m}$ .

## MICRO CRACK FEATURES

Cracks at the grain boundaries are a characteristic of polycrystalline CVD diamond growth. These macroscopic cracks are formed during synthesis and are a mechanism of intra and transgranular stress relief.



*For industrial lasers large area polycrystalline CVD diamond optics are more robust and reliable than the ZnSe optics they typically replace.*



# EMISSIONITY AND RF WINDOWS

## EMISSIONITY IN THE FAR INFRARED BAND

The residual absorption in the far infrared is due to the tail of the multi-phonon vibrational absorption processes. These are temperature dependent and diamond is emissive. However these processes are only significant above  $\sim 100^\circ\text{C}$  and the absorption is successfully described by a phonon recombination and destruction model.

## DIELECTRIC PROPERTIES

Diamond has a nearly constant dielectric constant from the terahertz region down to radio frequencies and beyond. The dielectric constant for diamond is at 35 GHz  $\epsilon = 5.68 \pm 0.15$  with a loss tangent of  $< 1 \times 10^{-4}$ .



*Polycrystalline Diamond Optics > 100 mm diameter are used in high power window applications.*

$$\epsilon(T) = 5.700111 - 5.35167 \times 10^{-5} T + 1.6603 \times 10^{-7} T^2$$

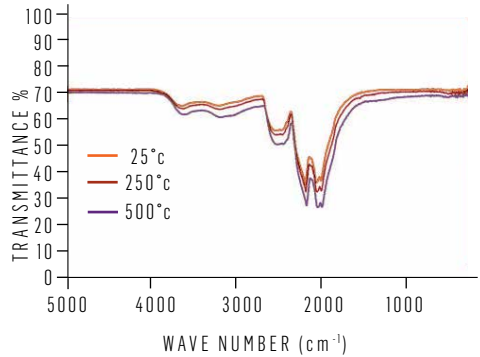

*The temperature dependent Infrared spectra of optical grade polycrystalline CVD diamond.*

TEMPERATURE °C	10.6 $\mu\text{m}$ Abs. $\text{cm}^{-1}$
25	0.035
100	0.063
150	0.082
200	0.102
250	0.123
300	0.145
350	0.168
400	0.191
450	0.216
500	0.241

*Approximate absorption coefficient as a function of temperature. See reference.*

# PRECISION COMPONENTS

	pCVD DIAMOND (OPTICAL THERMAL ELECTRONIC)	pCVD DIAMOND (MECHANICAL ELECTROCHEMICAL)	scCVD DIAMOND
SIZE THICKNESS	< $\Phi 85$ mm; < 2 mm	< $\Phi 130$ mm < 2 mm	8 × 8 mm < 2 mm
DIMENSIONAL TOLERANCE	-0, + 0.2 mm	-0, + 0.2 mm	-0, + 0.2 mm
THICKNESS	±25 $\mu$ m	±25 $\mu$ m	±25 $\mu$ m
CUT EDGE KERF ANGLE	3° ±2°	3° ±2°	3° ±2°
SURFACE ROUGHNESS LAPPED (Ra)	<200 nm	<200 nm	<200 nm
SURFACE ROUGHNESS POLISHED (Ra)	<20 nm	<20 nm	<5 nm
FLATNESS (633 nm)	1 fringe in 10 mm		1 fringe in 3 mm
ORIENTATION MISCUT			±3°
FACET ANGLE (PRISMS)			±0.25°

Specifications listed are typically production process limits. Tighter tolerances available on request.

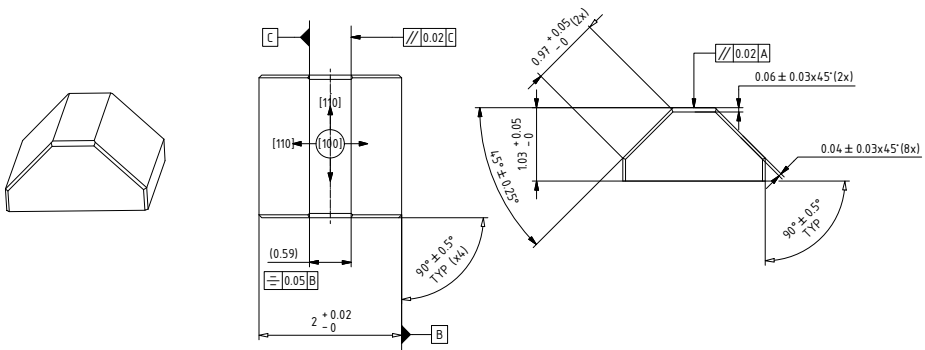

# THERMAL PROPERTIES

## THERMAL CONDUCTION

Unlike metals, heat conduction in diamond is dominated by lattice vibrations (phonons). The thermal conductivity is then determined by how these are scattered. In diamond, at room temperature, this is related to phonon-phonon scattering (Umklapp processes) and defect/impurity scattering. With grain size above  $\sim 50 \mu\text{m}$  and high phase purity, polycrystalline CVD diamond has been found to have a through plane conductivity varying by less than 10% of its in-plane value.

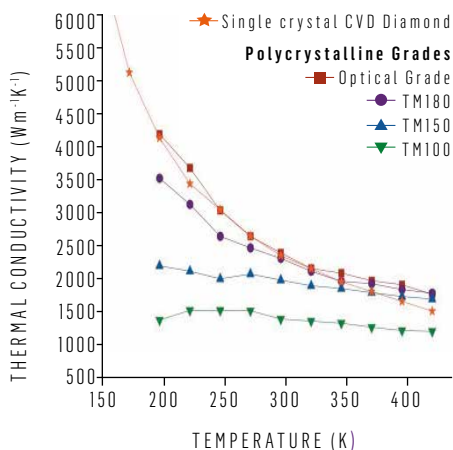

*The thermal conductivity of diamond versus temperature. In single crystal and high phase purity polycrystalline diamond, phonon scattering dominates. While finer grained materials exhibit a lower but less temperature dependent characteristics. Room temperature thermal conductivity of polycrystalline optical grade CVD diamond exceeds  $2000 \text{ Wm}^{-1}\text{K}^{-1}$*

## THERMAL EXPANSION

Diamond has an extremely low coefficient of thermal expansion, attributed to the very high bond energy. In general the expansion of materials is related to the phonon characteristics as a function of temperature and generally varies with temperature. Diamond has a low coefficient of thermal expansion at room temperature, rising steadily with temperature, as shown in the table below.

TEMP K	LINEAR COEFFICIENT ( $\alpha$ )	MEAN EXPANSION REFERENCED FROM 300K
200	0.45	-
300	1.05	-
400	1.79	1.09
500	2.7	1.47
600	3.17	1.84
800	3.81	2.39
1000	4.38	2.82
1200	4.93	3.18
1400	5.43	3.52
1600	5.87	3.82



*Polycrystalline thermal grades are used in heat spreading applications.*

# ELECTRONIC PROPERTIES

## SEMICONDUCTING PROPERTIES

Diamond is a wide bandgap semiconductor, with an indirect gap of 5.47 eV. Experiments on high purity CVD diamond have reported high mobility values and long lifetimes for electrons and holes. Combined with the high breakdown field and thermal conductivity, this makes diamond the preferred material for a number of demanding electronic applications.

Diamond's radiation hardness arises from its high atomic displacement energy (42 eV/atom) and low atomic number. Thus it can demonstrate stable high sensitivity to radiation in comparison to other solid state detector materials.

## DOPING DIAMOND

All known dopants for diamond are deep, however with  $B > 1 \times 10^{20}$  atoms  $\text{cm}^{-3}$ , the acceptor levels overlap with the valence band as the diamond undergoes the Mott transition to demonstrate metal-like p-type conductivity.

Due to the activation energy, n-type doping in diamond has only been considered for high temperature and UV applications, with limited success.

### POLYCRYSTALLINE SINGLE CRYSTAL

	POLYCRYSTALLINE	SINGLE CRYSTAL
<b>BAND GAP (eV)</b>	5.47	5.47
<b>[N]<sub>s</sub><sup>0</sup> (ppb) EPR</b>	< 50	< 5
<b>B (ppb) SIMS</b>	< 0.5	< 0.5
<b>DOPANTS</b>	Activation energy	Achievable Levels
<b>BORON</b>	0.37 eV	10 <sup>21</sup>
<b>PHOSPHORUS</b>	0.6 eV	10 <sup>20</sup>
<b>NITROGEN</b>	1.7 eV	10 <sup>19</sup> (111)



*High purity electronic grade polycrystalline diamond is used in high energy particle detector applications*

## BORON DOPED DIAMOND

Conducting, polycrystalline boron doped diamond (BDD) has the widest solvent window of all electrode materials in aqueous solution. It also has very low background and capacitive currents, and reduced fouling, compared to other electrodes along with the ability to withstand extreme potentials and harsh environments. However these properties are highly dependent on the diamond quality, with the properties improving as the non-diamond-carbon (NDC) content decreases. Free-standing, solid BDD electrodes can be grown with both trace and negligible NDC content.

## BDD APPLICATIONS

The very wide solvent window of diamond in aqueous solution pushes out gas evolution to very high cathodic/anodic potentials and enables the generation of highly oxidizing hydroxyl radical, with very high current efficiency. This process can be used in advanced oxidation processes. The inert characteristics of the BDD electrode make it an ideal platform for electrochemical sensing applications.

## ELECTROCHEMICAL PROPERTIES OF BDD

Polished bulk, free standing, polycrystalline BDD, with  $B > 1 \times 10^{20}$  atoms  $\text{cm}^{-3}$  and negligible NDC, with oxygen terminated surfaces, exhibits the following electrochemical properties:

- Resistivity  $\sim 0.5 \times 10^{-3}$  Ohm  $\text{cm}$
- Diamond Solvent window  $> 3.0$  V
- Reversibility  $< 70$  mV ( $\text{Ru}(\text{NH}_3)_6^{3+}$ )
- Capacitance  $< 10$   $\mu\text{F cm}^{-1}$

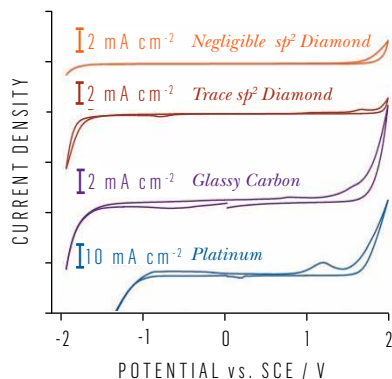

Solvent windows in  $0.1 \text{ M KNO}_3$ ,  $\text{pH } 6.5$ . For diamond electrodes the solvent window is heavily influenced by the non diamond carbon content of the BDD electrode.

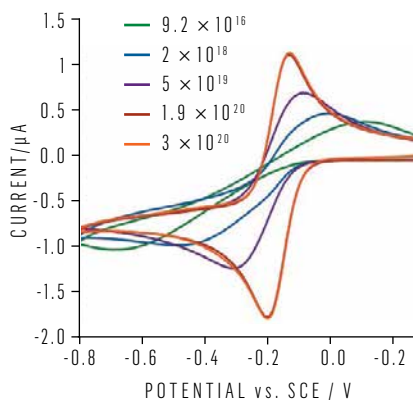

Cyclic Voltammetry for the redox couple  $\text{Ru}(\text{NH}_3)_6^{3+}$  illustrating that full reversibility can be achieved with boron concentrations above  $\sim 1 \times 10^{20}$  atoms  $\text{cm}^{-3}$  [Data for a 1 mm diameter electrodes, scan rate of  $0.1 \text{ V s}^{-1}$ ;  $1 \text{ mM Ru}(\text{NH}_3)_6^{3+}$  in  $0.1 \text{ M KNO}_3$ ]

# ELECTRONIC GRADES

PROPERTIES	SINGLE CRYSTAL	POLYCRYSTALLINE	COMMENTS
<b>ELECTRONIC</b>			
Hole mobility (cm <sup>2</sup> V <sup>-1</sup> s <sup>-1</sup> )	>2000	1000	
Electron mobility (cm <sup>2</sup> V <sup>-1</sup> s <sup>-1</sup> )	>2000	1800	
Carrier lifetime (ns)	~2000	- 1 - 10	
Charge collection distance	*Typically >475µm	†Typically >180µm	*At 0.5 V µm <sup>-1</sup> applied field, for 500 µm plate † At 1V µm <sup>-1</sup> applied field, for 500 µm plate
Charge Collection Efficiency	Typically >95%	Typically >36%	for 500 µm plate
Bandgap (eV)	5.47	5.47	
Electron saturation velocity (cms <sup>-1</sup> ) x 10 <sup>7</sup>	2	2	
Radiation Hardness cm <sup>-2</sup> 24 GeV protons		>10 <sup>15</sup>	With <25% signal drop
Breakdown Voltage (MV cm <sup>-1</sup> )	1 - 2		Experimental value. Threshold current 10 µA 4 x 4 mm x 20 µm contact area 0.71 mm <sup>2</sup>
<b>IMPURITIES</b>			
[N] <sub>s</sub> (ppb)	<5 ( typically 0.1 -1)	<50	Measured by EPR
[B] (ppb)	<1	<1	Measured by SIMS
<b>THERMAL PROPERTIES</b>			
Thermal conductivity (W m <sup>-1</sup> K <sup>-1</sup> )	>2000	> 1900	
Expansion Coefficient (ppm K <sup>-1</sup> ) at 300 K	1.0 ± 0.1	1.0 ± 0.1	
Expansion Coefficient (ppm K <sup>-1</sup> ) at 300 K	4.4 ± 0.1	4.4 ± 0.1	
<b>DIMENSIONS</b>			
Standard Sizes (mm)	2x2, 3x3, 4.5x4.5	5.5, 10x10, 20x20	Tolerance ± 0.05 mm Polycrystalline available up to Ø110mm
Standard thickness (mm)	0.3 & 0.5	0.3 & 0.5	Tolerance ± 0.05 mm
Laser kerf	3°	3°	
Edge Features (mm)	< 0.2	< 0.2	
Crystallographic Orientation (face / edge)	[100] ± 3° <110>		
<b>PROCESSED</b>			
Surface finish side 1 Ra (nm)	<0.5	Ra <20	Single crystal polished on {100} face
Surface finish side 2 Ra (nm)	<0.5	Ra <20	Single crystal polished on {100} face

# OPTICAL AND RF GRADES

PROPERTY	POLYCRYSTALLINE		SINGLE CRYSTAL	
	OPTICAL GRADE	RF GRADE	SINGLE CRYSTAL	OPTICAL GRADE
Hardness (GPa)	81 ± 18 <sup>(30)</sup>	81 ± 18 <sup>(30)</sup>	70 – 120 <sup>(3)</sup>	70 – 120 <sup>(3)</sup>
Fracture toughness (MPam <sup>0.5</sup> )	8.5 <sup>(3)</sup>	8.5 <sup>(3)</sup>	5 – 7 <sup>(3)</sup>	5 – 7 <sup>(3)</sup>
Young's modulus (GPa)	1054 <sup>(3)</sup>	1054 <sup>(3)</sup>	1054 <sup>(3)</sup>	1054 <sup>(3)</sup>
Poisson's ratio	0.1 <sup>(3)</sup>	0.1 <sup>(3)</sup>	0.1 <sup>(3)</sup>	0.1 <sup>(3)</sup>
Fracture Stress (MPa) [Weibull Modulus]			3500 [2.5] <sup>(3)</sup>	3500 [2.5] <sup>(3)</sup>
Nucleation surface	800 [10]	800 [10]		
Growth surface	400 [15]	300 [15]		
Rain impact DTV (ms <sup>-1</sup> ) 2 mm drop size	525 <sup>(31)</sup>		457 – 533 <sup>(31)</sup>	-
Sand erosion (mg/kg) at 100 ms <sup>-1</sup> C300/600 sand	2.1 ± 0.6 <sup>(30)</sup>		-	-
Thermal conductivity at 300 K (Wm <sup>-1</sup> K <sup>-1</sup> )	1900 – 2200	1900 – 2200	1900 – 2200	>2000
Thermal conductivity at 500 K (Wm <sup>-1</sup> K <sup>-1</sup> )	1100	1100	1100	1100
Thermal expansion coefficient (ppmK <sup>-1</sup> )	1.0 at 300 K	1.0 at 300 K	1.0 at 300 K <sup>(22)</sup>	1.0 at 300 K
	4.4 at 1000 K	4.4 at 1000 K	4.4 at 1000 K <sup>(22)</sup>	4.4 at 1000 K
Refractive index (10.6 μm)	2.376 <sup>(30)</sup>		2.376 <sup>(30)</sup>	2.376 <sup>(30)</sup>
(1550 nm)	2.386		2.386	2.386
(1064 nm)	2.392		2.392	2.392
dn/dT (K <sup>-1</sup> )	9.6 x 10 <sup>-6</sup> <sup>(30)</sup>		9.6 x 10 <sup>-6</sup> <sup>(30)</sup>	9.6 x 10 <sup>-6</sup> <sup>(30)</sup>
Dielectric constant D (35 GHz)	5.68 ± 0.15 <sup>(30)</sup>	5.68 ± 0.15 <sup>(30)</sup>	-	-
Loss tangent 145 GHz (10 <sup>-5</sup> )	8 – 20 <sup>(32)</sup>	10 – 100 <sup>(32)</sup>	-	-
10.6 μm absorption coefficient (cm <sup>-1</sup> )	<0.07		<0.05 <sup>(12)</sup>	<0.05
3 – 5 μm absorption coefficient (cm <sup>-1</sup> )	min 0.8 at 3.7 μm <sup>(30)</sup>		min 0.8 at 3.7 μm <sup>(30)</sup>	min 0.8 at 3.7 μm <sup>(30)</sup>
1.064 μm absorption coefficient (cm <sup>-1</sup> )	Typical 0.12 <sup>(12)</sup>		<0.1 <sup>(12)</sup>	<0.005 <sup>(12)</sup>
Emissivity at 10 μm (1 mm thick)	0.02 at 573 K		0.02 at 573 K	0.02 at 573 K
	0.3 at 773 K <sup>(19)</sup>		0.03 at 773 K <sup>(19)</sup>	0.03 at 773 K <sup>(19)</sup>
Integrated forward scatter 8 – 12 μm (%)	0.1 – 0.7% <sup>(19)</sup>		-	NA
Integrated forward scatter visible (%)	<4% <sup>(19)</sup>		<0.7% <sup>(12)</sup>	0.10%
Birefringence (η <sub>e</sub> - η <sub>o</sub> )			1 x 10 <sup>-4</sup> <sup>(18)</sup>	to 1 x 10 <sup>-6</sup> <sup>(18)</sup>
Specific heat capacity (Jkg <sup>-1</sup> K <sup>-1</sup> ) 300K	520 <sup>(21)</sup>	520 <sup>(21)</sup>	520 <sup>(21)</sup>	520 <sup>(21)</sup>
Transmission 8 – 2.00 μm (1 mm thick)	71.4% #	68-70% #	71.4% #	71.4% #
Transmission 633 nm (1 mm thick)	>64% #		>69% #	70.6% #

For references <sup>(xxx)</sup> see page 27 # = Reflection & scattering loss limited. - = Not known

# MECHANICAL GRADES

PROPERTY	DIAFILM CDD	DIAFILM CDM	DIAFILM CDE	MCC - SINGLE CRYSTAL
<b>THERMAL CONDUCTIVITY</b>				
@ 300 K ( $\text{Wm}^{-1}\text{K}^{-1}$ )	>1100	>1000	>600	>1900
@ 425 K ( $\text{Wm}^{-1}\text{K}^{-1}$ )	>950	>900	>500	>1500
<b>THERMAL EXPANSION COEFFICIENT</b>				
@ 300 K ( $\text{ppmK}^{-1}$ )	$1.0 \pm 0.1$	$1.0 \pm 0.1$	$1.0 \pm 0.1$	$1.0 \pm 0.1$
@ 1000 K ( $\text{ppmK}^{-1}$ )	$4.4 \pm 0.1$	$4.4 \pm 0.1$	$4.4 \pm 0.1$	$4.4 \pm 0.1$
<b>THERMAL DIFFUSIVITY</b>				
300 K ( $\text{cm}^2\text{s}^{-1}$ )	>5.5	>8.3	>10.0	>11.1
<b>SPECIFIC HEAT CAPACITY</b>				
300 K ( $\text{Jkg}^{-1}\text{K}^{-1}$ )	520	520	520	520
<b>HARDNESS</b>				
300 K (GPa)	$80 \pm 18$	$80 \pm 18$	$80 \pm 18$	70 - 120†
FRACTURE STRESS (MPa)	Growth - Nucleation 500 - 1100	Growth - Nucleation 500 - 1100	Growth - Nucleation 500 - 1100	Surface finish 2000 - 3000
<b>FRACTURE TOUGHNESS</b>				
( $\text{MPam}^{0.5}$ )	8.5	8.5	8.5	5
<b>YOUNG'S MODULUS</b>				
(GPa)	1050	1050	1050	1050
Poisson's ratio	0.1	0.1	0.1	0.1
<b>DENSITY</b>				
( $10^3 \text{ kgm}^{-3}$ )	3.52	3.52	3.52	3.52
<b>RESISTIVITY</b>				
Bulk $R_v$ ( $\Omega \text{ cm}$ )	$1 \times 10^{12}$	$1 \times 10^{12}$	0.05 - 0.07	$1 \times 10^{12}$

† Orientation dependent



# THERMAL GRADES

PROPERTY	DIAFILM 100	DIAFILM 150	DIAFILM 180	DIAFILM 200
<b>THERMAL CONDUCTIVITY</b>				
@ 300 K ( $\text{Wm}^{-1}\text{K}^{-1}$ )	>1000	>1500	>1800	>2000
@ 425 K ( $\text{Wm}^{-1}\text{K}^{-1}$ )	>900	>1400	>1500	>1500
<b>THERMAL EXPANSION COEFFICIENT</b>				
@ 300 K ( $\text{ppmK}^{-1}$ )	$1.0 \pm 0.1$	$1.0 \pm 0.1$	$1.0 \pm 0.1$	$1.0 \pm 0.1$
@ 1000 K ( $\text{ppmK}^{-1}$ )	$4.4 \pm 0.1$	$4.4 \pm 0.1$	$4.4 \pm 0.1$	$4.4 \pm 0.1$
<b>THERMAL DIFFUSIVITY</b>				
300 K ( $\text{cm}^2\text{s}^{-1}$ )	>5.5	>8.3	>10.0	>11.1
<b>SPECIFIC HEAT CAPACITY</b>				
@ 300 K ( $\text{Jkg}^{-1}\text{K}^{-1}$ )	520	520	520	520
<b>HARDNESS</b>				
GPa	$81 \pm 18$	$81 \pm 18$	$81 \pm 18$	$81 \pm 18$
<b>FRACTURE TOUGHNESS</b>				
( $\text{MPam}^{0.5}$ )	5.3 – 7.0	5.3 – 7.0	5.3 – 7.0	5.3 – 7.0
<b>YOUNG'S MODULUS</b>				
(GPa)	1050	1050	1050	1050
Poisson's ratio	0.1	0.1	0.1	0.1
<b>DENSITY</b>				
( $10^3 \text{kgm}^{-3}$ )	3.52	3.52	3.52	3.52
<b>RESISTIVITY</b>				
Bulk $R_v$ ( $10^{12} \Omega \text{cm}$ )	1	1	1	1
Surface $R_s$ ( $10^{10} \Omega \text{cm}$ )	1	1	1	1

# ELECTROCHEMICAL PROCESSING GRADE

PROPERTIES	EP GRADE	COMMENT
<b>ELECTROCHEMICAL PROPERTIES</b>		
Boron doping concentration (typical)	$2 \text{ to } 6 \times 10^{20} \text{ Atoms cm}^{-3}$	Averaged over $0.16 \text{ mm}^2$
Non diamond Carbon	Trace	As measured by Raman Spectroscopy
Resistivity ( $\Omega \text{ m}$ )	$0.2 - 1.8 \times 10^{-3}$	$\pm 0.25 \times 10^{-3}$
Contact resistivity ( $\Omega \text{ m}$ )	$< 1 \times 10^{-3}$	For Ti:Pt:Au metallisation
Values quoted measured with ohmic contacted diamond with polished surfaces		
Solvent window* (V)	$> 3.0$	$0.1 \text{ M KNO}_3$ versus SCE
Capacitance* ( $\mu\text{F cm}^{-2}$ )	$< 20 \mu\text{F}$	Derived from cyclic voltammetry at a scan rate of $0.1 \text{ Vs}^{-1}$
Reversibility ( $\Delta E_p$ )* (mV)	$< 100$	Recorded at a $1 \text{ mm}$ diameter disc electrode with $1 \text{ mM Ru}(\text{NH}_3)_6^{3+/2+}$ at a scan rate of $100 \text{ mVs}^{-1}$ when an ohmic contact to diamond is made.
Erosion Rate ( $\mu\text{g h}^{-1} \text{ m}^{-2}$ )	$< 6$	Measured at $10000 \text{ Am}^{-2}$
Operating Current Density ( $\text{A m}^{-2}$ )	$> 20000$	$2 \text{ mm}$ spacing $50 \text{ mS cm}^{-1}$ electrolyte
<b>MECHANICAL PROPERTIES</b>		
Nucleation side fracture stress (MPa)	$> 800$	
Growth side fracture stress (MPa)	$> 450$	
Young's modulus (GPa)	1050	
Fracture toughness ( $\text{MPa m}^{0.5}$ )	8.5	
Weibull modulus	$> 10$	
Hardness (GPa)	$81 \pm 18$	
<b>THERMAL PROPERTIES</b>		
Thermal conductivity ( $\text{Wm}^{-1}\text{K}^{-1}$ )	$\sim 700$	Through plane @ $300 \text{ K}$
<b>DIMENSIONAL TOLERANCE UN-PROCESSED</b>		
Thickness uniformity	$\pm 2.5\%$	Typical values
Nucleation side roughness ( $\mu\text{m}$ )	$R_a < 0.5$	Typical values
Growth face roughness ( $\mu\text{m}$ )	$R_a < 200$	Typical values
Max area available (round $\text{mm}^2$ )	12 270	Diameter $130 \text{ mm}$
Max area available (rectangle $\text{mm}^2$ )	7150	Rectangle $110 \times 65 \text{ mm}$
Lateral dimensional tolerance (mm)	$\pm 0.2$	All edges are laser cut
<b>PROCESSED</b>		
Lapped face roughness ( $\mu\text{m}$ )	$R_a < 0.25$	Standard tolerance
Polished face roughness ( $\mu\text{m}$ )	$R_a < 0.03$	Standard tolerance
Thickness tolerance (mm)	$\pm 0.05$	Standard tolerance

\*Values quoted measured for ohmic contacted diamond with  $R_a < 0.03 \mu\text{m}$  surface finish

*The Element Six CVD Diamond Handbook*

# FURTHER READING

1. *Monolithic Diamond Raman Lasers* Reilly S et al. *Optics Letters* [http://www.opticsinfobase.org/ol/upcoming\\_pdf.cfm?id=228892](http://www.opticsinfobase.org/ol/upcoming_pdf.cfm?id=228892)
2. *Special Issue on Science's Gem: Diamond Science 2009* Mainwood A, et al <http://dx.doi.org/10.1088/0953-8984/21/36/360301>
3. *The Mechanical and Strength Properties of Diamond* Field JE 2012 <http://dx.doi.org/10.1088/0034-4885/75/12/126505>
4. *The "Type" Classification System of Diamonds and Its Importance in Gemology: Breeding C Metal.* <http://www.gia.edu/gems-gemology/summer-2009-type-classification-system-diamonds-breeding>
5. *Diamond synthesis by chemical vapor deposition: The early years* Angus 2014 <http://dx.doi.org/10.1016/j.diamond.2014.08.004>
6. *A review of diamond synthesis by CVD processes* 2011 Schwander M <http://dx.doi.org/10.1016/j.diamond.2011.08.005>
7. *Chemical vapour deposition synthetic diamond: materials, technology and applications* 2009 R S Balmer et. <http://dx.doi.org/10.1088/0953-8984/21/36/364221> <http://arxiv.org/abs/0909.1185>
8. *The Structure of Diamond* Bragg WH Bragg WL 1913 <http://www.jstor.org/stable/93489>
9. *Diamond polishing* Schuelke T et al 2013 <http://dx.doi.org/10.1016/j.diamond.2012.11.007>
10. *Diamond surfaces: familiar and amazing.* Ristein J. 2006 *Appl. Phys. A*, 82, 377-384 <http://dx.doi.org/10.1007/s00339-005-3363-5>
11. *Influence of the brazing parameters on microstructure, residual stresses and shear strength of diamond-metal joints* 2010 Buhl, S et al. *J Mater Sci* 45:4358-4368 <http://dx.doi.org/10.1007/s10853-010-4260-7>
12. *Single crystal and polycrystalline CVD diamond for demanding optical applications* 2011 J M Dodson et al <http://dx.doi.org/10.1117/12.885188>
13. *Infrared refractive index of diamond* Edwards et al *OSA*, Vol. 71, Issue 5, pp. 607-608 (1981) <http://dx.doi.org/10.1364/JOSA.71.000607>
14. *Temperature dependence of the refractive index of diamond up to 925 K* 2000 Ruf, T et al. <http://dx.doi.org/10.1103/PhysRevB.62.16378>
15. *Diamond micro-Raman thermometers for accurate gate temperature measurements* 2014 Simon R B et al <http://dx.doi.org/10.1063/1.4879849>
16. *Raman spectroscopy of diamond and doped diamond* 2004 Praver S et al 362, 2537-2565 <http://dx.doi.org/10.1098/rsta.2004.1451>
17. *Highly efficient diamond Raman laser* 2009 Mildren RP et al *Optics Letters*, 34, pp. 2811-2813 <http://dx.doi.org/10.1364/OL.34.002811>
18. *Control of surface and bulk crystalline quality in single crystal diamond grown by chemical vapour deposition.* 2009 Friel I et al. *Dia. & Rel. Mat.* 18 ( ) 808-815 <http://dx.doi.org/10.1016/j.diamond.2009.01.013> <http://arxiv.org/abs/0909.1200>
19. *Factors affecting the optical performance of CVD diamond infrared optics* 2003 Mollart TP et al <http://dx.doi.org/10.1088/0268-1242/18/3/317>
20. *Temperature dependence of intrinsic infra-red absorption in natural and chemical-vapor deposited diamond* 2002 C Piccirillo G Davies et al *J. Appl. Phys.* 92, 756 2002 <http://dx.doi.org/10.1063/1.1483380>
21. *Thermal conductivity measurements on CVD diamond* 2001 Twitchen D J et al. [http://dx.doi.org/10.1016/S0925-9635\(00\)00515-X](http://dx.doi.org/10.1016/S0925-9635(00)00515-X)
22. *Thermal expansion of some diamondlike crystals* Slack G A et al (1975), *J Appl Phys*, 46, pp - 98 <http://dx.doi.org/10.1063/1.321373>
23. *High mobility diamonds and particle detectors* 2006 Pernegger H <http://dx.doi.org/10.1002/pssa.200671404>
24. *Activation energy in low compensated homoepitaxial boron-doped diamond films* 1998 Lagrange J P et al, *Diam. Relat. Mat.* 1998, 7, 1390-1393, DOI: [http://dx.doi.org/10.1016/S0925-9635\(98\)00225-8](http://dx.doi.org/10.1016/S0925-9635(98)00225-8)
25. *A practical guide to using boron doped diamond in electrochemical research* 2015 Macpherson J V <http://dx.doi.org/10.1039/c4cp04022h>
26. *Advanced oxidation processes for water treatment: advances and trends for R&D* 2008 Conninellis C et al <http://dx.doi.org/10.1002/jctb.1873>
27. *CVD Diamond - Integrating a Superior Thermal Material* 2014 Obeloer et al *Electronics Cooling* September 2014 <http://www.electronics-cooling.com/2014/09/cvd-diamond-integrating-superior-thermal-material/>
28. *Applications of Synthetic Diamond* [http://www.e6.com/wps/wcm/connect/E6\\_Content\\_EN/Home/Applications/](http://www.e6.com/wps/wcm/connect/E6_Content_EN/Home/Applications/)
29. *Thermal stability of metallized CVD diamond* 1996 C.D Iacovangelo [http://dx.doi.org/10.1016/S0040-6090\(95\)08236-0](http://dx.doi.org/10.1016/S0040-6090(95)08236-0)
30. *Materials for Infrared Windows and Domes* 1999 Harris DC SPIE, *Optical Engineering Press*, ISBN 0819434825.
31. *The liquid Impact Resistance of CVD Diamond and other Infrared Materials* 1999 Coad E.J. and J.E. Field, <http://dx.doi.org/10.1117/12.277041>
32. *FZK Report, FZKA 6815, 2003. M.Thumm*, <http://www.ubka.uni-karlsruhe.de/volltexte/fz-k/6815/6815.pdf>

## ELEMENT SIX

Element Six is a member of the De Beers Group of Companies, its majority shareholder. Element Six designs, develops and produces synthetic diamond supermaterials, and operates worldwide with its head office registered in Luxembourg, and primary manufacturing facilities in U.S., Germany, Ireland, South Africa and the U.K.

Element Six supermaterial solutions are used in applications such as cutting, grinding, drilling, shearing and polishing. Today Element Six is a \$500 million company serving over 5,000 customers worldwide.

Element Six Technologies, a division of Element Six, is dedicated to the design, development and manufacture of the extreme properties of synthetic diamond beyond hardness - opening up new applications in a wide array of industries such as optics, power transmission, water treatment, semiconductors and sensors. Element Six Technologies operates two CVD diamond production around the globe; Santa Clara in California, and Ascot in the U.K.

Element Six Technologies US  
Corporation\*  
3901 Burton Drive  
Santa Clara  
CA 95054  
USA

Tel: +1 408 986 2400  
Email: [ustechnologies@e6.com](mailto:ustechnologies@e6.com)

Element Six Technologies  
Kings Ride Park  
Ascot  
Berkshire  
SL5 8BP  
UK

Tel: +44 1344 638 200  
Email: [technologies@e6.com](mailto:technologies@e6.com)

Element Six Ltd  
9F PMO Hatchobori  
3-22-13 Hatchobori  
Chuo-ku, Tokyo  
Japan 104-0032

Tel: +81 3 3523 9311  
Email: [japan.technologies@e6.com](mailto:japan.technologies@e6.com)

Element Six Trading (Shanghai) Co. Ltd  
2802A, Chong Hing Finance Center,  
No. 288 Nan Jing Road West,  
Huang Pu District,  
Shanghai, 200003,  
China

Tel: +86 (0)21 6359 5999  
Email: [china.technologies@e6.com](mailto:china.technologies@e6.com)

*\*Registered with the Department of State for handling ITAR sensitive and controlled defense projects.*